



Submersible Sewage Pumps
Vortex Impeller

PU



Made of stainless steel and special resin, the PU-series submersible pumps are lightweight and rust free. The vortex impeller and large passage facilitate pump operations to readily dispose of liquids containing various kinds of foreign matters.

① Anti-wicking cable entry



Each cable entry is devised at its entry into the pump so that it may prevent drainage incursion into the motor due to a capillarity.

A portion of each conductor is stripped back and sealed by molded rubber which flows in between each strand of the conductor thus preventing 'wicking.'

the conductor thus preventing 'wicking.'

④ Back pull-out design

Unfastening the bolts between the oil casing and the upper pump casing allows the body to be separated into the pump section and the motor section with the impeller left in position. This facilitates inspections of the main portions. The pump section can be disassembled/reassembled using a large Phillips screw driver.



② Motor

Dry, squirrel-cage induction motor secured in a watertight stainless steel case. Class E insulation is provided. The pump is usable at an ambient temperature of not higher than 40 °C.

③ Motor protector



Every PU-series pump is equipped with a motor protection device which directly cuts the motor circuitry in case of an excessive heat buildup in the motor or an overcurrent caused by some electrical or mechanical failure.

⑤ Mechanical seal

All PU-series pumps are furnished with a dual inside mechanical seal made of silicon carbide. The seal is located in an oil chamber completely outside the drainage so as to eliminate:

- a spring failure, due to corrosion, abrasion or fouling, which can prevent the seal faces from closing properly and/or
- the loss of cooling effects on the bottom seal faces under dry run conditions, which can cause a bottom seal failure.

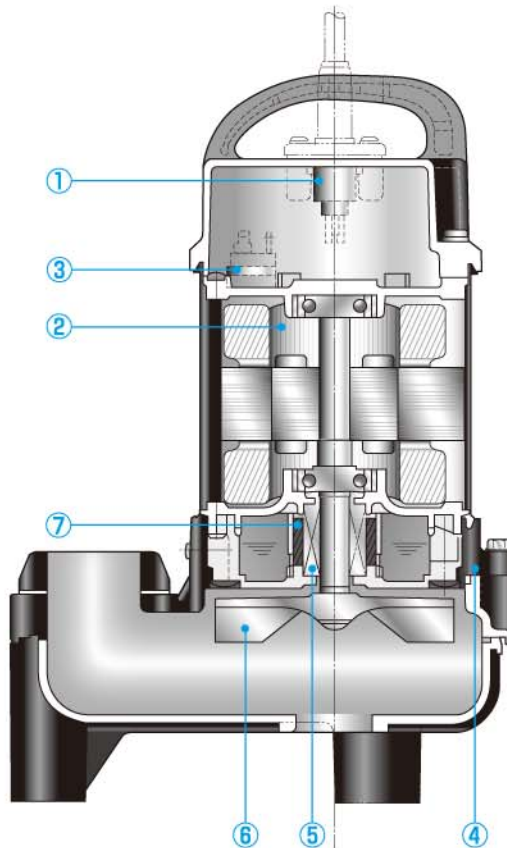

⑦ Oil Lifter (Pat. Pending)

Every pump has a built-in Oil Lifter designed to stabilize the mechanical seal function by efficiently supplying the lubricant to the seal even if it drops to below the rated level. This amazingly simple device turns otherwise wasted energy into an additional protection effect for the seal and extends both seal life and maintenance intervals.

⑥ Impeller



A vortex impeller is installed in the upper section of the pump casing. The impeller, coupled with a large passage in the casing,

allows the pump to handle coarse solids up to 35 mm in grain diameter.



COMPOSITION OF THE MODEL NAME

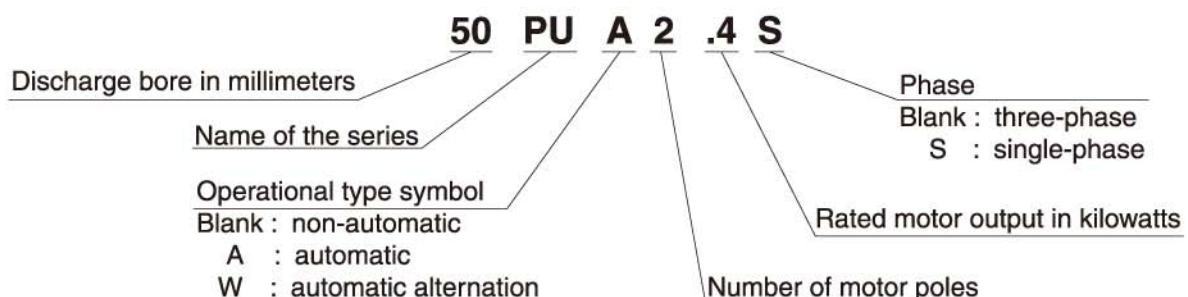

Performance curves

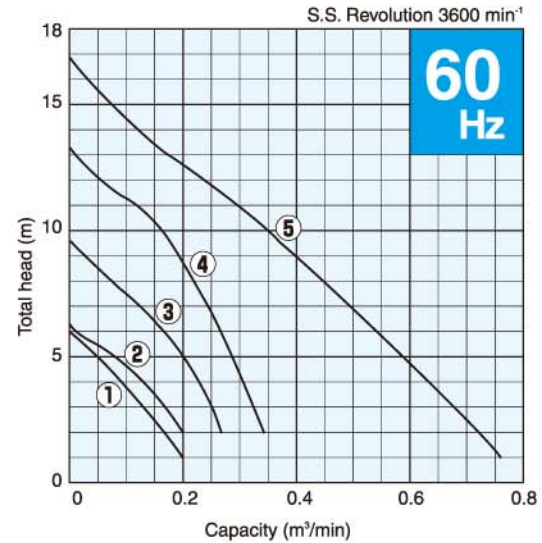
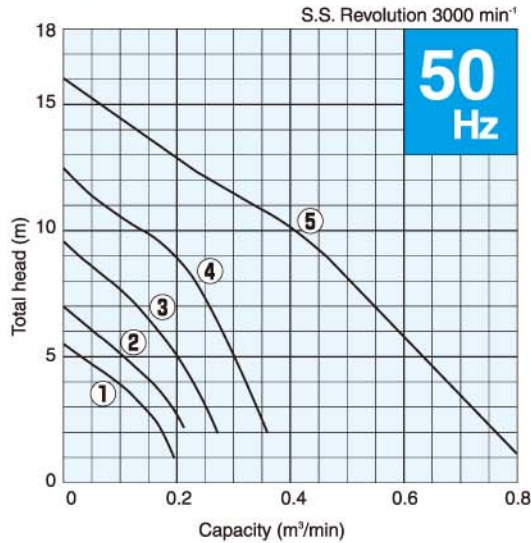

Specifications

Curve No.	Discharge bore mm	Standard Model	Automatic Model	Auto-alternation Model	Motor output kW	Phase	Revolutions 50Hz/60Hz min ⁻¹	Starting method	Impeller passage mm	Standard cable length m	Cable code ref.	Dimensions L × H mm		Dry weight kg	
												Standard	Auto & Auto alternation	Standard	Auto & Auto alternation
1	40	40PU2.15S	40PUA2.15S	40PUW2.15S	0.15	Single	3000/3600	Capacitor Run	35	5	a	225 × 378	225 × 378	6.6	7.0
	40	40PU2.15	40PUA2.15	40PUW2.15	0.15	Three	3000/3600	D.O.L.	35	6	A	225 × 378	225 × 378	5.8	6.2
2	40	40PU2.25S	40PUA2.25S	40PUW2.25S	0.25	Single	3000/3600	Capacitor Run	35	5	a	236 × 360	236 × 374	7.1	7.7
	40	40PU2.25	40PUA2.25	40PUW2.25	0.25	Three	3000/3600	D.O.L.	35	6	A	236 × 349	236 × 363	6.1	6.7
3	50	50PU2.4S	50PUA2.4S	50PUW2.4S	0.4	Single	3000/3600	Capacitor Run	35	5	a	236 × 360	236 × 374	7.1	7.7
	50	50PU2.4	50PUA2.4	50PUW2.4	0.4	Three	3000/3600	D.O.L.	35	6	A	236 × 360	236 × 374	7.0	7.5
4	50	50PU2.75S	50PUA2.75S	—	0.75	Single	3000/3600	Capacitor Run	35	5	a	236 × 374	236 × 388	8.9	9.5
	50	50PU2.75	50PUA2.75	50PUW2.75	0.75	Three	3000/3600	D.O.L.	35	6	A	236 × 374	236 × 388	8.3	8.9
5	80	80PU21.5	80PUA21.5	80PUW21.5	1.5	Three	3000/3600	D.O.L.	46	6	A	295 × 475	295 × 475	15.8	16.5

Cabtyre Cable

Single-Phase

Code	Pcs/unit	Cores × mm ²	Dia. mm	Material
a	1	3 × 1.25	10.1	PVC Sheath

Three-Phase

Code	Pcs/unit	Cores × mm ²	Dia. mm	Material
A	1	4 × 1.25	11.1	PVC Sheath

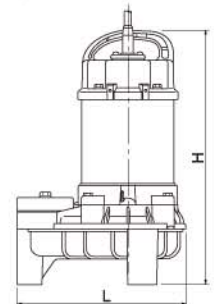

Special Accessory

TOK guide rail fittings

Tsurumi provides TOK-type guide rail fittings for all PU-series pumps. The fittings connect a pump to, or separate it from, piping only by lifting the pump up/down. No need to enter in the pump sump for maintenance.



Advantages

No water leak

Rubber bellows attached to the guide hook are inverted to the duckfoot bend when the pump starts operation. The bellows are kept inverted while the pump is stopped. This eliminates leaks even if a lightweight pump is connected with the guide hook.

Immune to rust

The guide hook, guide support and duckfoot bend are made of high-quality resin and secured in position with stainless steel bolts and washers. This prevents corrosion completely.

Type of TOK and applicable pumps:

TOK Model	Applicable Pump Models
TOK4-P	Pumps of 0.15kW to 0.75kW
TOK2-65	Model 80PU21.5

Contents of TOK

- 1 × Duckfoot Bend
 - 1 × Upper Guide Support
 - 1 × Guide Hook
 - 1 × Lifting Chain(4m by TOK4-P, 5m by TOK2-65)
 - 1 × Rubber Bellows
- (The foundation bolts, two numbers required, are not included.)

Automatic pumps

Tsurumi Automatic pumps have an integral control circuit and two float switches operated at low voltages.

The automatic pumps are indicated by the symbol, A, added to the series name in the model code.

They are available in all sizes of the series.



Automatic Alternation pumps

Tsurumi also offers Automatic Alternation pumps for dual automatic operations using two pumps at a time. Just combine an ordinary automatic pump (2 floats) to an automatic alternation pump (3 floats). This enables the two pumps to operate alternately without control panel.

The automatic alternation pumps are identified by the symbol, W, added to the series name in the model code. They are available in the same output ranges as those of the ordinary automatic models.

How the Auto-alternation Type Works

● Operation is enabled by merely connecting the power supply.

Primary Operation

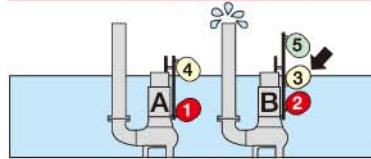

1 Float 3 operates, and pump B starts to discharge water.

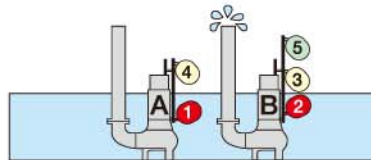

2 Water is discharged (water level falls).

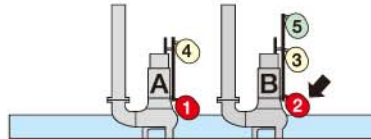

3 Stop float 2 of pump B operates to end water discharge. At this time, alternation start float 3 of pump B rests for one discharge operation.

Secondary Operation

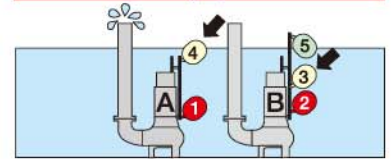

1 Start float 4 of pump A operates to start water discharge. The pump ends primary operation, and stops operating.

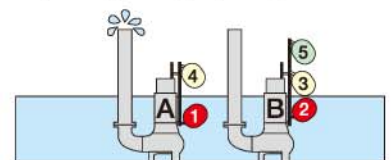

2 Water is discharged (water level falls).

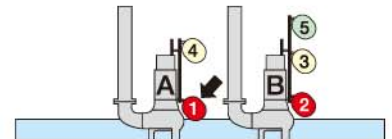

3 Stop float 1 of pump A operates to end water discharge. At the same time, start float 3 of pump B becomes ready for operation.

※Primary operation and secondary operation are repeated alternately.

※Both primary and secondary operations are performed simultaneously when water has risen to an abnormal level.

The specifications and designs here in may be changed for improvement without notice.

TSURUMI
MANUFACTURING CO.,LTD.